

PYLE®

10.2" TFTLCD COLOR MONITOR/DVD

Instruction Manual

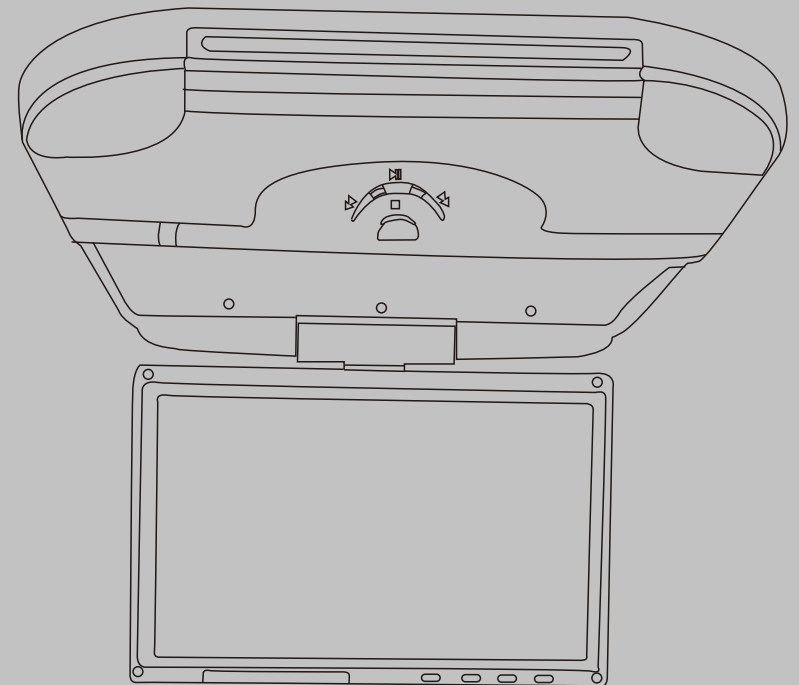

WWW.PYLEAUDIO.COM

WARNING:
HAZARD DO NOT OPERATE THIS
UNIT UNLESS VEHICLE IS PARKED
IN SAFE AND LEGAL AREA

PLRD102

1. SPECIFICATIONS

TFT-LCD MONITOR

Screen size: 10.2 inch 16:9 TFT

Resolution: 800 (H)x600(V)

Power source : DC12V±20%

Electric current: 1.35A±20%

System: PAL/NTSC

Operation temperature: -10°C-55°C

Storage temperature: -10°C-80°C

Disc zone: multizone

Disc format compatible: MP3, SVCD, VCD, DVD, CD, CD-R, CD-RW, DVD-RW, DVD-R

2: NOTICE

A. Please do not try to repair. The display screen is composed of lots of precise electronic components. They will be broken or cracked if disassembled or refitted. If the failure happened, please turn off the monitor and notify distributors or us.

B. Don't let the display screen incur the pollution like dampness, dust, steam, lampblack, etc.

C. Please don't use thinner or other chemical cleaner to wipe the surface of the display screen. The dirt should be wiped off by using soft cloth.

D. Keep the monitor away from extreme hot and cold locations.

E. Avoid dropping and strong impact.

3. REMINDING:

DO NOT HIT THE SCREEN, PLEASE CONNECT THE ANODE AND CATHODE OF POWER CORRECTLY.

DANGEROUS HIGH VOLTAGE ARE PRESENT INSIDE THE ENCLOSURE. DO NOT OPEN THE CABINET. REFER SERVICING TO QUALIFIED PERSONNEL ONLY.

No inform available if there is any change of specification

ATTACHMENT

1. MAINTAIN OF LCD

A: Do not press or touch LCD, which may cause distortion or fault.

B: Use soft cloth with a little water clean LCD.

C: Do not use oil, thinner, cleanser or anlistatig.

D: In cold or hot condition, picture may not clear, any new LCD may has red or blue light point, 99.99% on the LCD should be without any point but 0.01% point appeared is allowed.

Spare parts list

Item no	description	Q'ty
1	power, A/V cable	1
2	remote control	1
3	manual	1
4	screws	1 bag
5	5M RCA cable	1

Attachment

1. maintain of DVD MONITOR

please use normally rotund disc. If you put in an abnormity, not rotund disc, they will be locked by the player or can not play well.

Make sure the disc before play has no split, scratch or warp.

Do not touch the record surface (not printed side)

Keep disc in the disc pack after playing;

Do not expose disc under direct sunlight or high temperature;

Do not stick label, write or use chemical on the surface of disc;

If you use central heating in cold weather, you may find dews on the DVD player, which may make the unit can not work well. Then please cut off the unit for 1 hour to make it dry and wipe the disc by dry cloth.

Shock may cause the play stop.

2. MAINTAIN OF DISC

A: some functions may not available for certain kinds of DISCS.

B: some discs may not compatible with this unit.

C: this unit can only play DVD-R/DVD-RW disc in video mode, and some files download from computer can not be read.

D: broken, dirty or wet disc can not be read.

E: some disc recorded by personal may can not be read for the format of recording.

F: when play MP3 format , adopt special method to playing, because of the special MP3 format of document storage.

G: should use ← ↑ → ↓ ↓ to choose the file when play MP3 disc, closed by ENTER.

3. MAINTAIN OF REMOTE CONTROL

A: Do not expose it in direct sunlight or put in on the instrument board

B: Especially in summer, the high temperature there will make it distorted

C: the unit may can not receive the signal from the remote control under direct sunlight, move it near to the unit

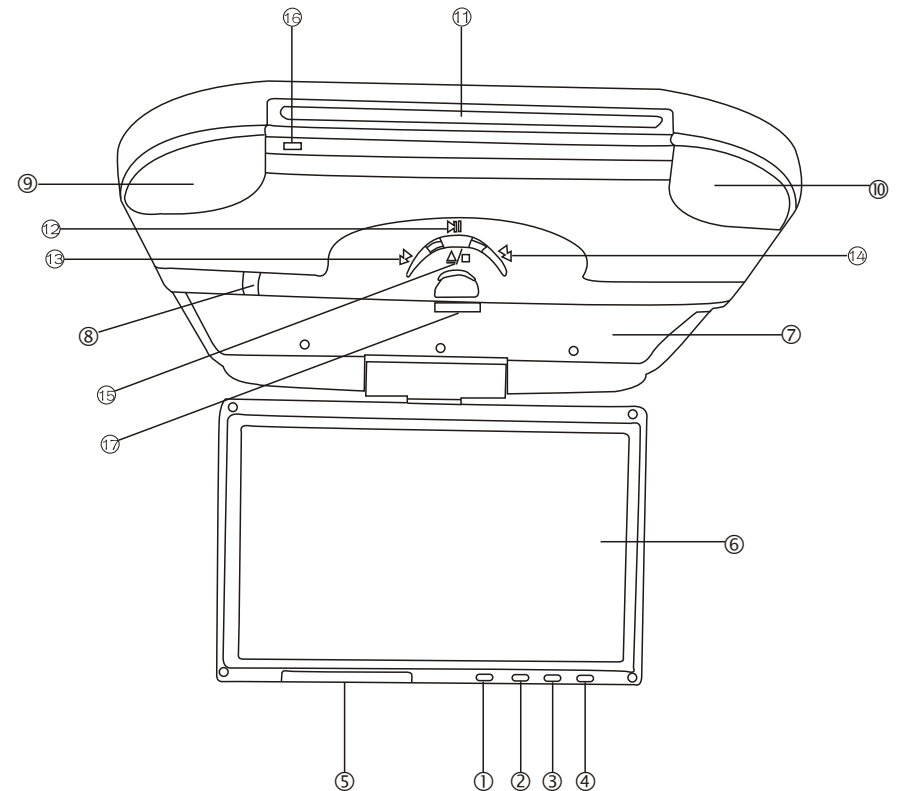

1) Power (control display)

2) -

5) IR TRANSMIT

7) FIX PEDESTAL

9) LEFT LAMP

11) EJECT

13) BACKWARD

15) STOP

17) OPEN

3) MENU

4) +

6) LCD MONITOR

8) LAMP BUTTON

10) RIGHT LAMP

12) PLAY/PAUSE

14) FAST FORWARD

16) DVD INDICATOR

Installation

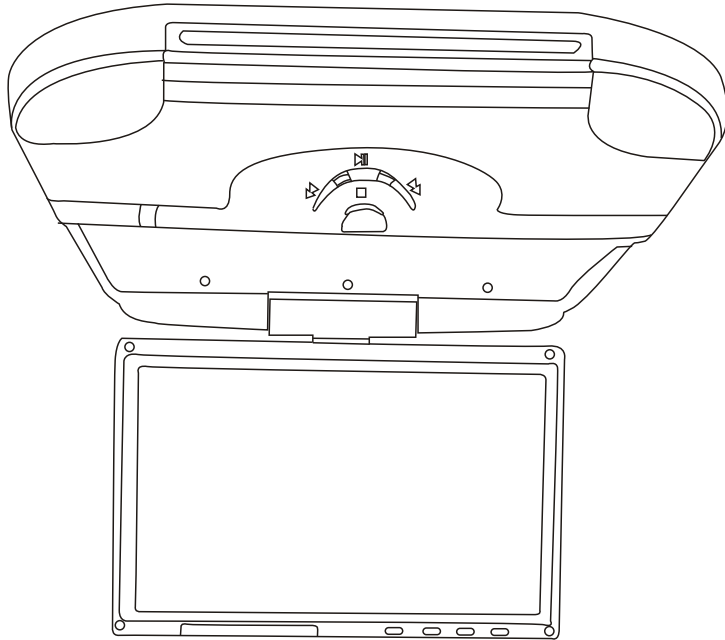

3.INSTALLATION

Use the 6 pieces of machine screws(4x20BA) , and fix the setting plate to the place, then assembly the unit of monitor to the setting plate.

BASIC TROUBLE SHOOTING

Fault	reason	resolvent
No power	red wire goes to 12v +; black one goes to ground	connect power correctly
	Fuse Blowout	change fuse
	Power line unconnected	connect correctly to the power
No picture	no VD input	input video
	No dvd signals output	reset dvd
	Video lines unconnected	connect video line again
Remote useless	battery protection paper unload Aim at wrong direction	take out the paper aim at the receiver window
	No power	change battery
Can not play	bad disc	change better disc
Distortion	disc load in mistake way	re-put disc
	Disc dirty	clean disc
	Fast forward/ backward	Normally

REMOTE CONTROL FUNCTIONS

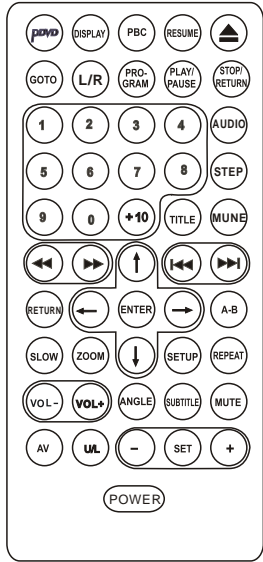

1. PDVD: DVD power
2. DISPLAY: show information about disc
3. PBC: when it plays super VCD, VCD2.0, it can show menu of the song: song 1, song 2,--- choose number directly.
4. RESUME: memorial play
5. ▲ Inhale / eject disc
6. GOTO: set time
7. L/R: right / left channel
8. PRO-GRAM: edit
9. PLAY/PAUSE: press once, it plays or stops play; press again , it returns.
10. STOP: stop play if press this button
11. 1~10: number
12. AUDIO: mode of audio
13. STEP: press this button, it will play next picture; press PLAY, it comes to normally mode.
14. TITLE: back to main page
15. MENU: menu
16. ►► Next song

17. ◀◀ Last song
18. ►► fast forward
19. ◀◀ Fast backward
20. A-B: repeat play start part A to part B by press this button two times (first press is A and the second is B), press third time, it stops repeat play.
21. RETURN: back to main menu
22. ENTER: confirm
23. ← ↑ → ↓ : direction
24. SLOW: play slowly
25. ZOOM: zoom the picture with 4 class
26. SETUP: set
27. REPEAT: repeat play
28. VOL-: lower
29. VOL+: louder
30. ANGLE: video angle
31. SUBTITLE
32. MUTE
33. AV
34. U/L: display start up or down way
35. -: reduce
36. SEL: menu
37. +: increase
38. POWER: power of this monitor

WIRING DIAGRAM

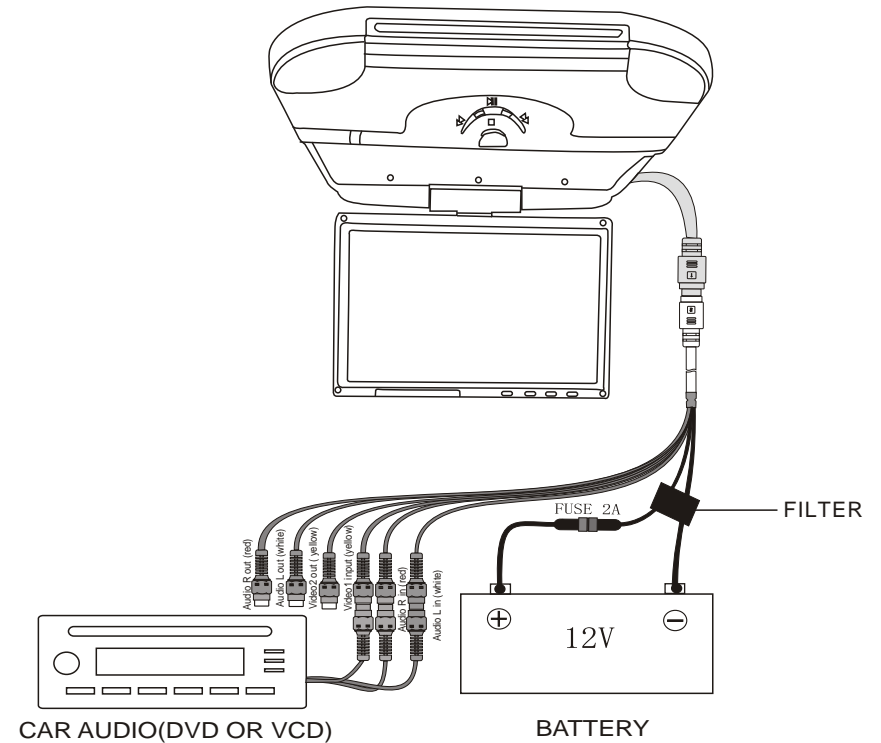

Wiring diagram

- Step 1 : please take out power signal cable from attached bag, long cable connect the thrum ,as per arrow direction, with screen signal thrum insert it correctly
- Step 2: connect the power correctly, red cable is anode , black cable is cathode
- Setp 3: signal cable (1 way) is video input,one of red cable and white cable are left and right audio input, others are left and right output. (please see the tag)

FUNCTIONS

1) Brightness

Enter into MENU, use + - buttons to adjust the picture's brightness, can adjust the range in 0~100. attached is the main menu.

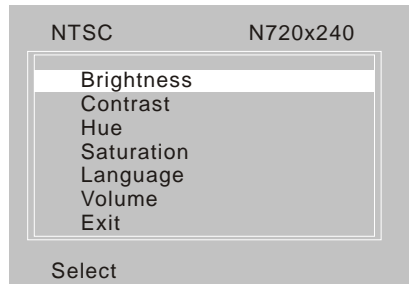

2) Contrast

Enter into MENU, use " + " " - " buttons to adjust the picture's contrast. Can adjust the range in 0~100. attached is the main menu.

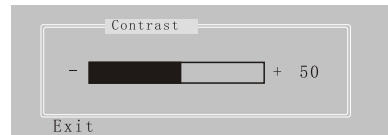
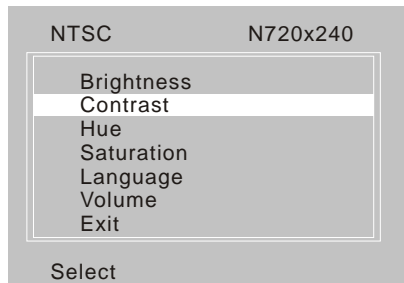

3) Hue

Enter into MENU, use " + " " - " buttons to adjust the picture's hue. can adjust the range in 0~100. this function apply to the NTSC system only. normally, adjust the range of hug in 50. attached is the main menu.

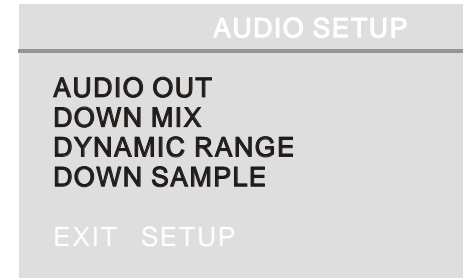
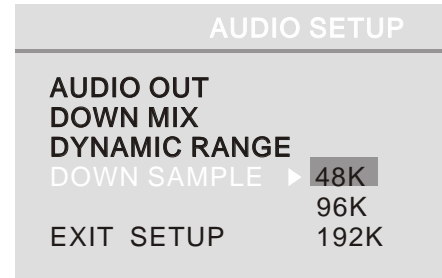
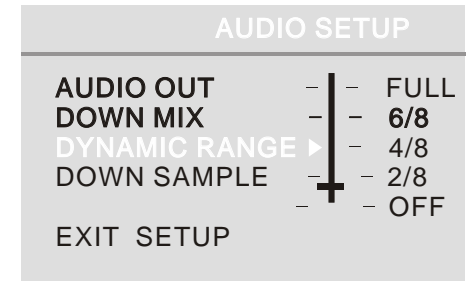
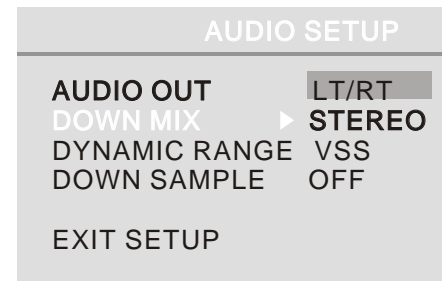
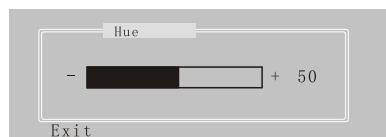
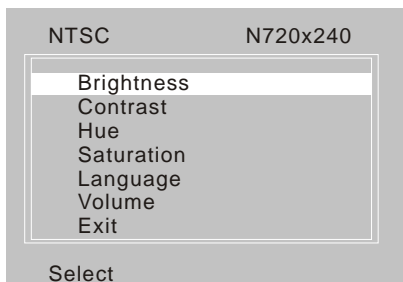

NOTICE:

- A: Should use ← ↑ → ↓ to set and ENTER to confirm your set.
- B: do not change preset if unnecessary
- C: if this set compatible with PAL and NTSC, it would be better choose NTSC
- D: Original password is 0000
- E: part of the functions are available only under certain condition, while some are not available right now.

Playing edit

if there are two tiles or songs above in the disc, use PRO-GRAM button to set the order, it will show 1[--],2[--]---on the picture, so press the number to edit the order, then you can use → and ENTER to play.

B: language setting

Press **SETUP** to set up the language , attached is the main menu and sub menu:

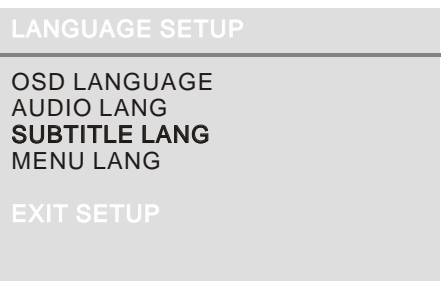
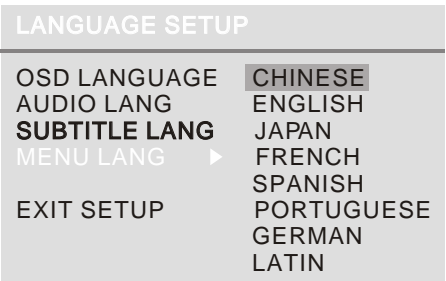
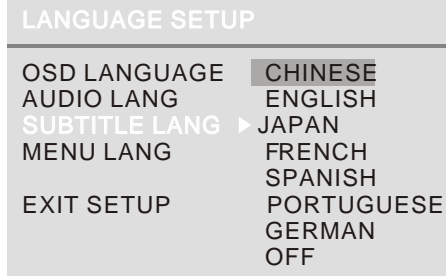
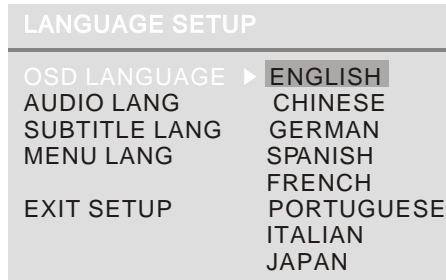
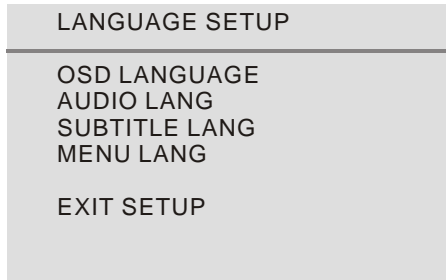

C: audio setting

Press **SETUP** to set up the audio, attached is the main menu and sub menu:

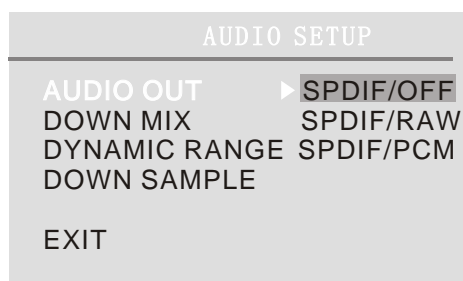
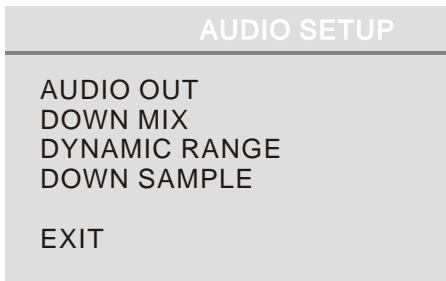

4)saturation

Enter into **MENU**, use + - buttons to adjust the picture' s saturation. can adjust the range in 0~100.attached is the main menu.

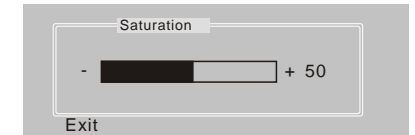
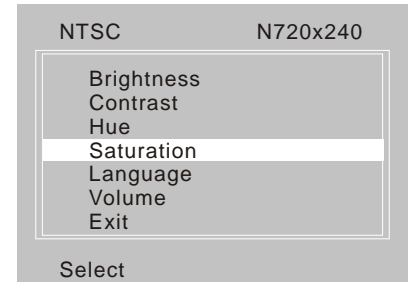

5)Language

Enter into **MENU**, use + - buttons to adjust the picture' s language. Can adjust the range in 0---100.attached is the main menu.

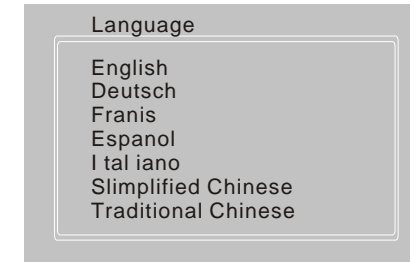
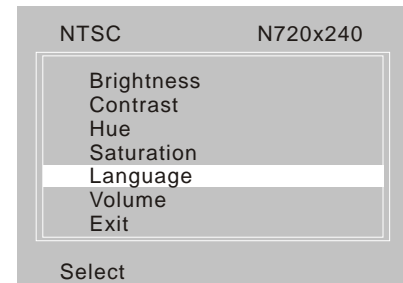

6)Volume

N/A

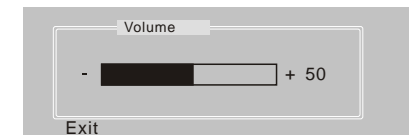
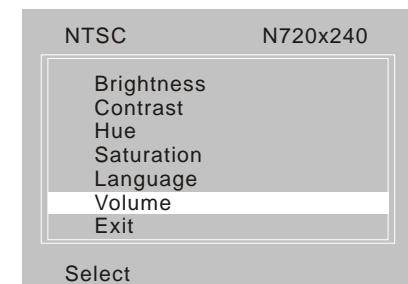

7)Exit

Enter into MENU, use " + " " - " buttons to adjust the exit

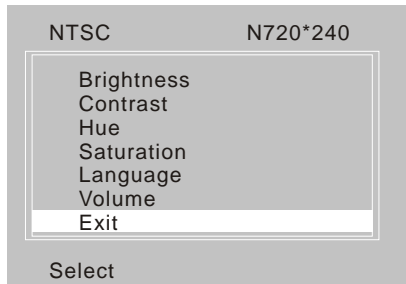

DVD FUNCTIONS

1). DVD PLAYER

DVD reading indication light will gleam when loading DVD DISC; and then when disc is reading the light turns to be shining.

2) PAUSE

press **⏸** when playing , it will pause playing for you to see inactive picture.

Press it again, it will go on playing.

3)STOP

Press **■** it will stop playing

4)FAST FORWARD / BACKWARD

press " **⏮** " " **⏭** " to fast forward and backward when playing DVD, while press " **⏩** " to go on playing.

5)LAST/NEXT

press " **⏪** " " **⏩** " to chose last or next song by remote control.

6)TURN TO APPOINTED MENU OR TIME

press GOTO one time, will show following picture:

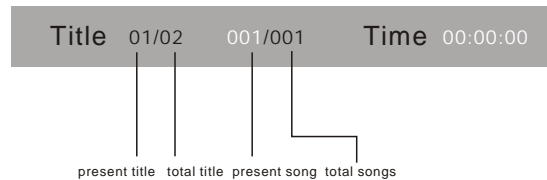

press " **→** " on the remote control to present song, then input the number of the song or the time you want closed by ENTER, If the number is 10 above, press 10 and then the number.

7)DVD INFO

Press " **DISPLAY** " on the remote control to display DVD information .

8)DVD player menu

Press " **MENU** " on the remote control to turn into DVD menu, as per play menu, enter into number to choice the program.

9) DVD TITLE

Turn to DVD title by press TITLE on the remote control.

10) DVD SETTING

A: normally setting

press SETUP to preset DVD , Attached is the main menu and sub menu.

